

Sept. 24, 1940.

E. U. CONDON ET AL

2,215,544

MACHINE TO PLAY GAME OF NIM

Original Filed April 26, 1940 11 Sheets-Sheet 1

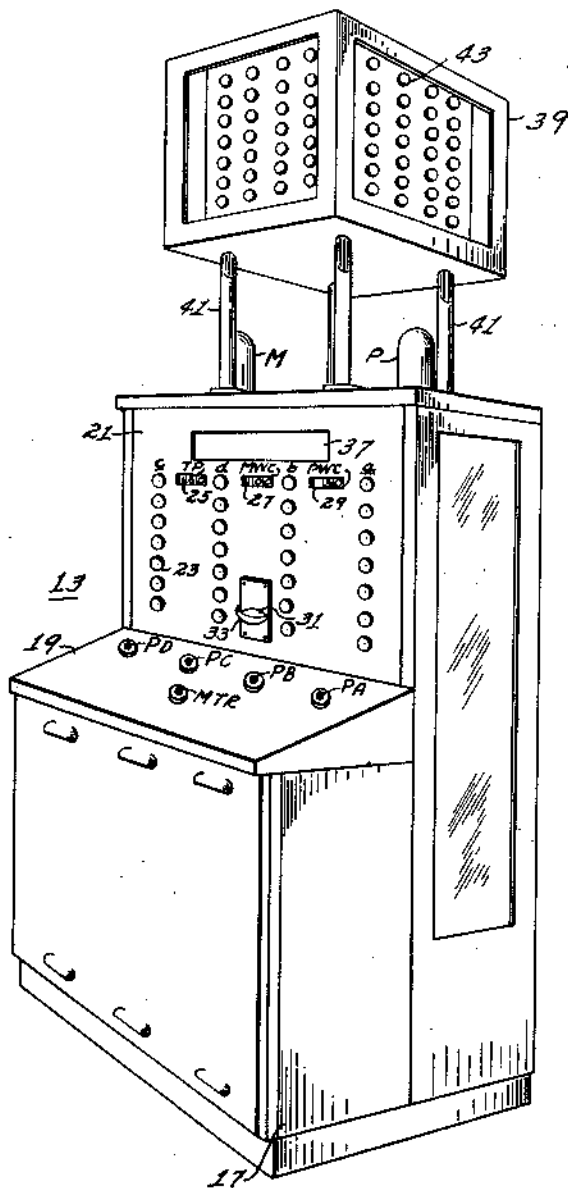

WITNESSES:

*James F. Young*  
*Wynne Diamond*

Fig. 1.

INVENTORS  
Edward U. Condon, Gerald L. Tawney,  
and Willard A. Derr.

BY

*F. W. Saylor*  
ATTORNEY

Sept. 24, 1940.

E. U. CONDON ET AL

2,215,544

MACHINE TO PLAY GAME OF NIM

Original Filed April 26, 1940 11 Sheets-Sheet 2

Fig. 2.

Fig. 3.

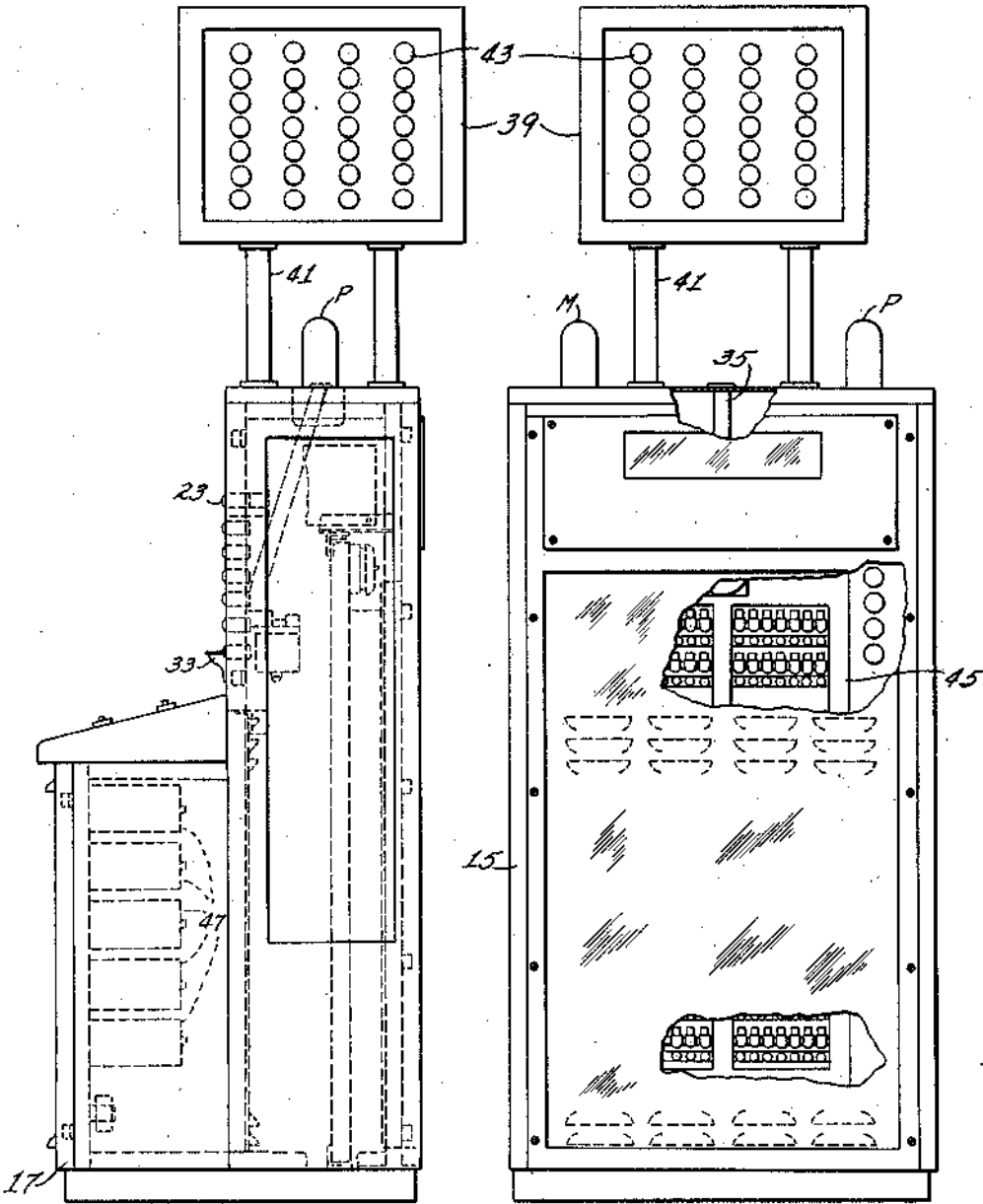

WITNESSES:

*James F. Young*  
*Hyman Diamond*

INVENTORS

*Edward U. Condon, Gerald L. Tawney,*  
*and Willard A. Derr.*

BY

*F. W. Lytle.*  
ATTORNEY

Sept. 24, 1940.

E. U. CONDON ET AL

2,215,544

MACHINE TO PLAY GAME OF NIM

Original Filed April 26, 1940 11 Sheets-Sheet 3

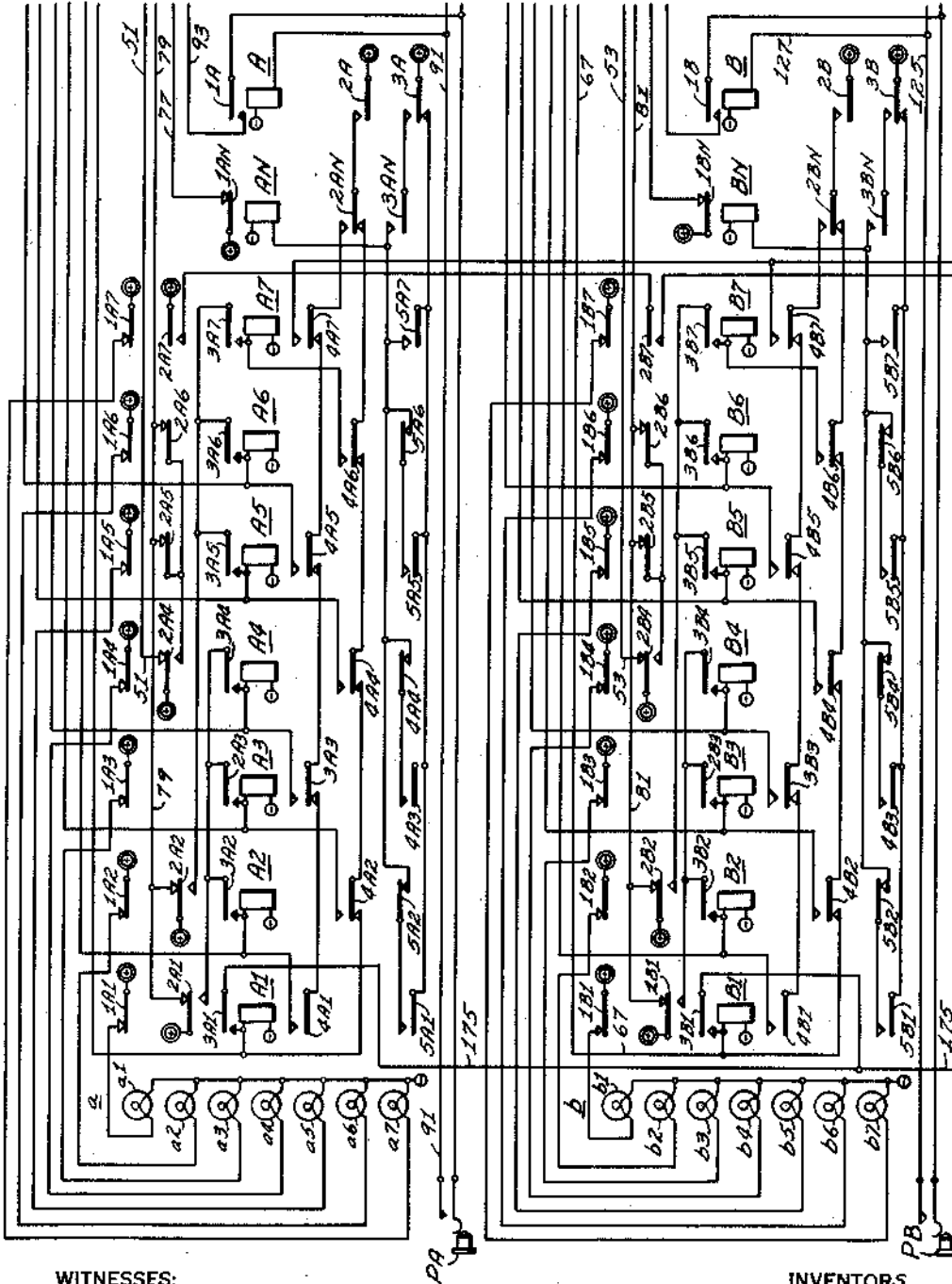

WITNESSES:

*James F. Young*  
*Kymon R. Leonard*

Fig. 4.

INVENTORS  
 Edward U. Condon, Gerald L. Towney,  
 and Willard A. Derr.

BY

*F. W. Seyle*  
 ATTORNEY

Sept. 24, 1940.

E. U. CONDON ET AL

2,215,544

MACHINE TO PLAY GAME OF NIM

Original Filed April 26, 1940 11 Sheets-Sheet 4

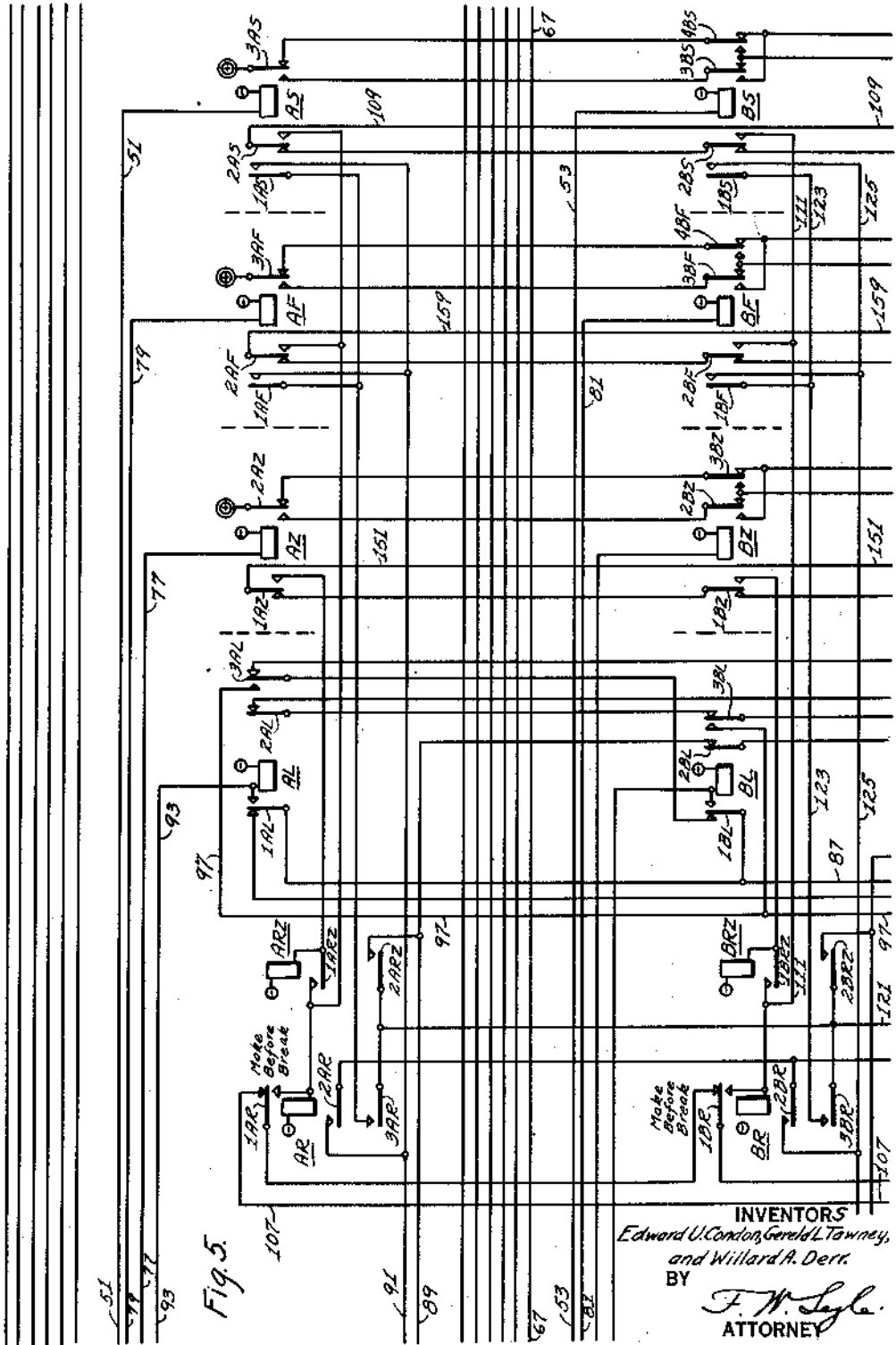

Fig. 5.

INVENTORS  
 Edward U. Condon, Gerald L. Towney,  
 and Willard A. Derr.  
 BY  
*F. W. Lytle.*  
 ATTORNEY

Sept. 24, 1940.

E. U. CONDON ET AL.

2,215,544

MACHINE TO PLAY GAME OF NIM

Original Filed April 26, 1940 11 Sheets-Sheet 5

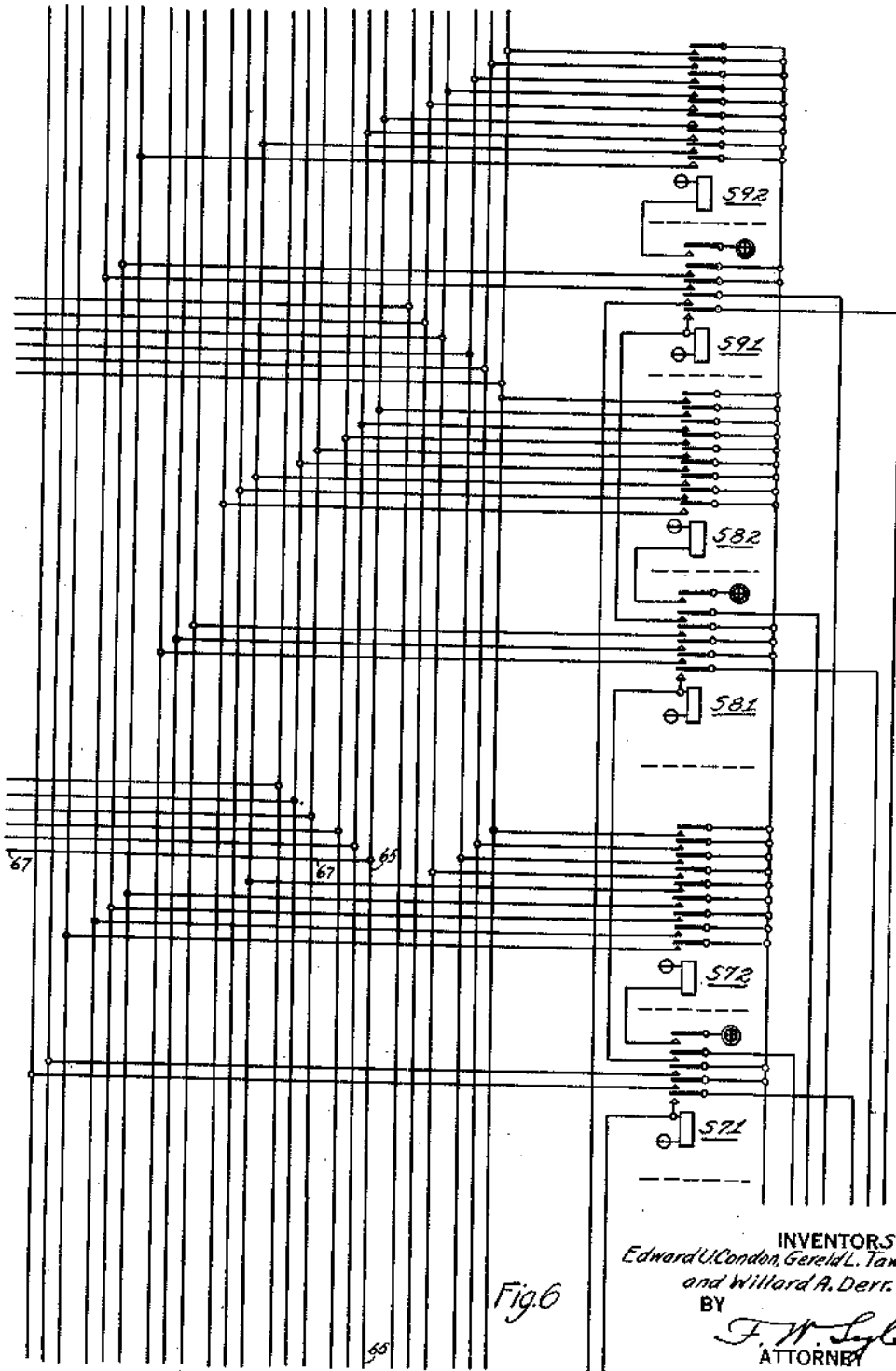

INVENTORS  
Edward U. Condon, Gerald L. Tawney,  
and Willard A. Derr.  
BY  
*F. W. Lytle*  
ATTORNEY





Sept. 24, 1940.

E. U. CONDON ET AL

2,215,544

MACHINE TO PLAY GAME OF NIM

Original Filed April 26, 1940 11 Sheets-Sheet 8

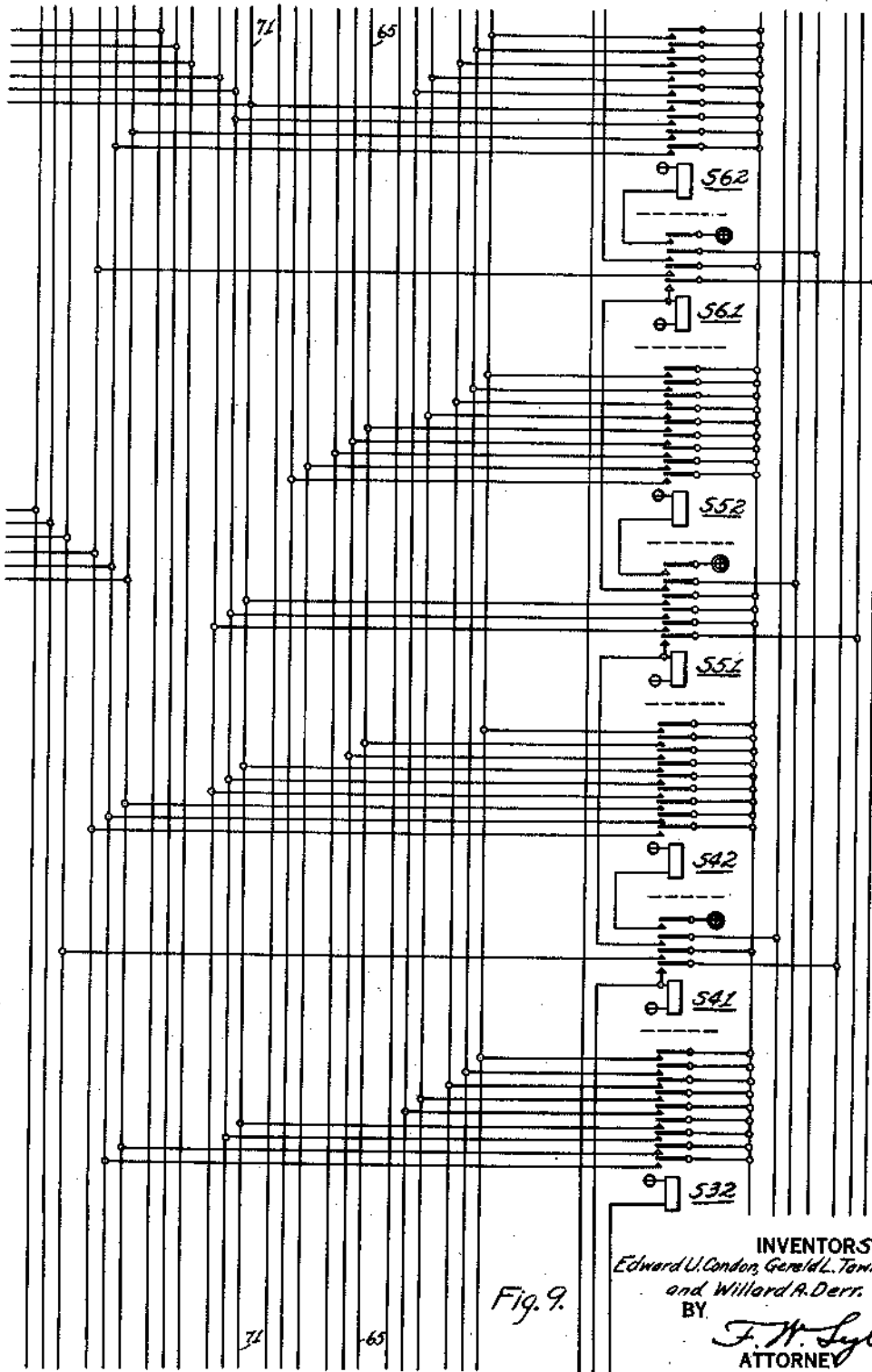

Fig. 9.

INVENTORS  
Edward U. Condon, Gerald L. Tanney,  
and Willard A. Derr.  
BY  
*F. W. Syle*  
ATTORNEY



Sept. 24, 1940.

E. U. CONDON ET AL

2,215,544

MACHINE TO PLAY GAME OF NIM

Original Filed April 26, 1940 11 Sheets-Sheet 9

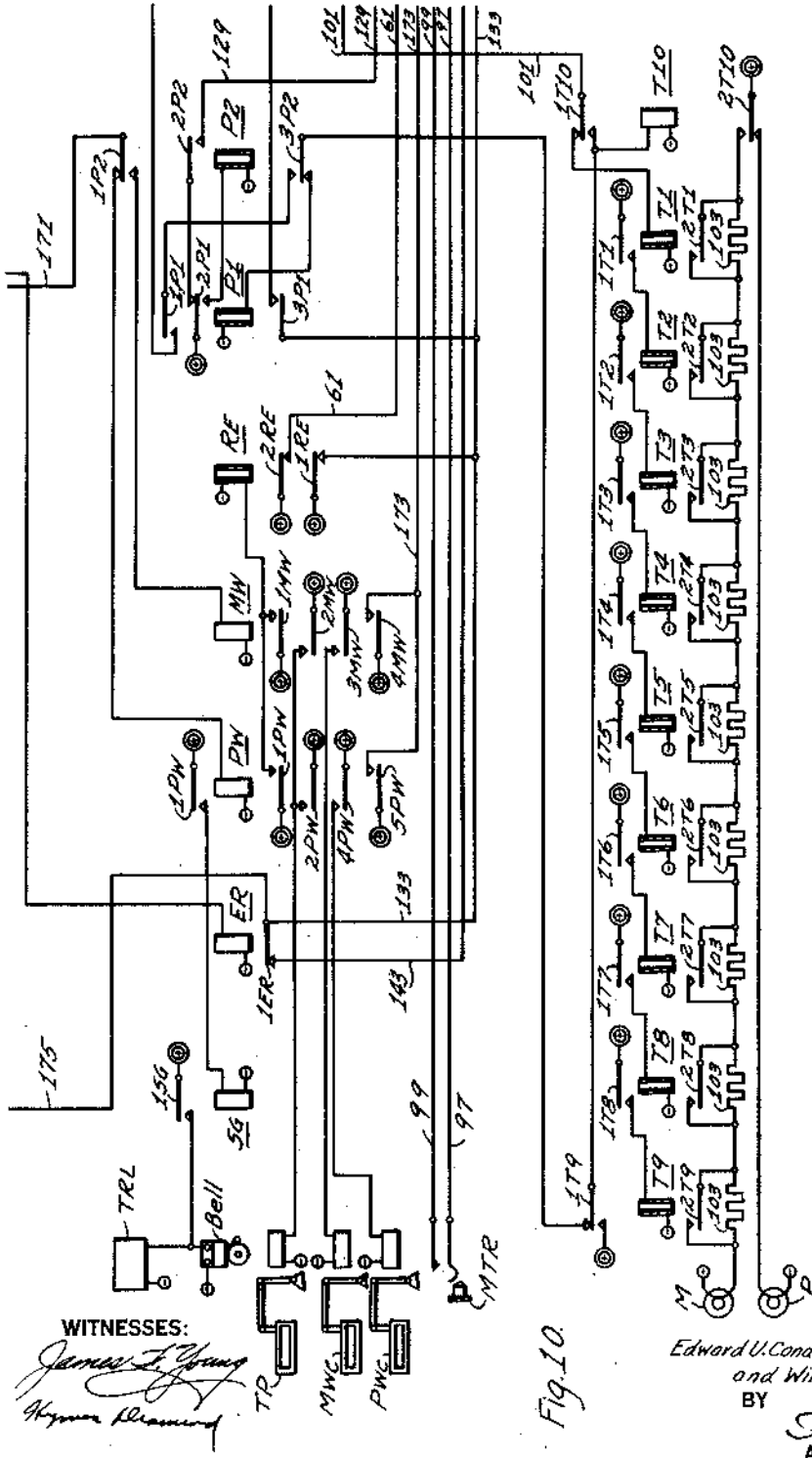

Fig. 10.

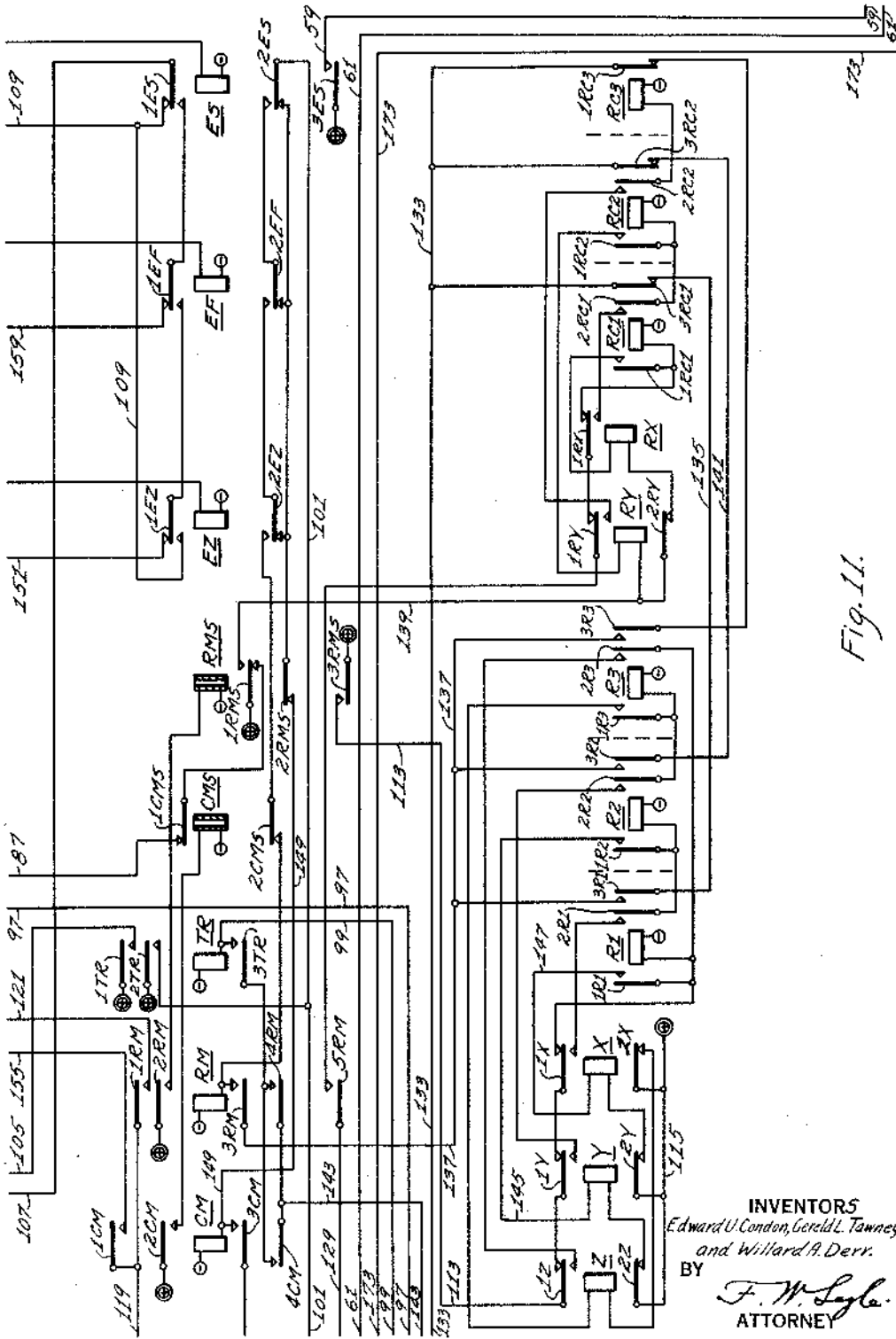

Fig. 11.

INVENTORS  
 Edward U. Condon, Gerald L. Tawney,  
 and Willard A. Derr.  
 BY  
*F. W. Lytle.*  
 ATTORNEY

Sept. 24, 1940.

E. U. CONDON ET AL

2,215,544

MACHINE TO PLAY GAME OF NIM

Original Filed April 26, 1940 11 Sheets-Sheet 11

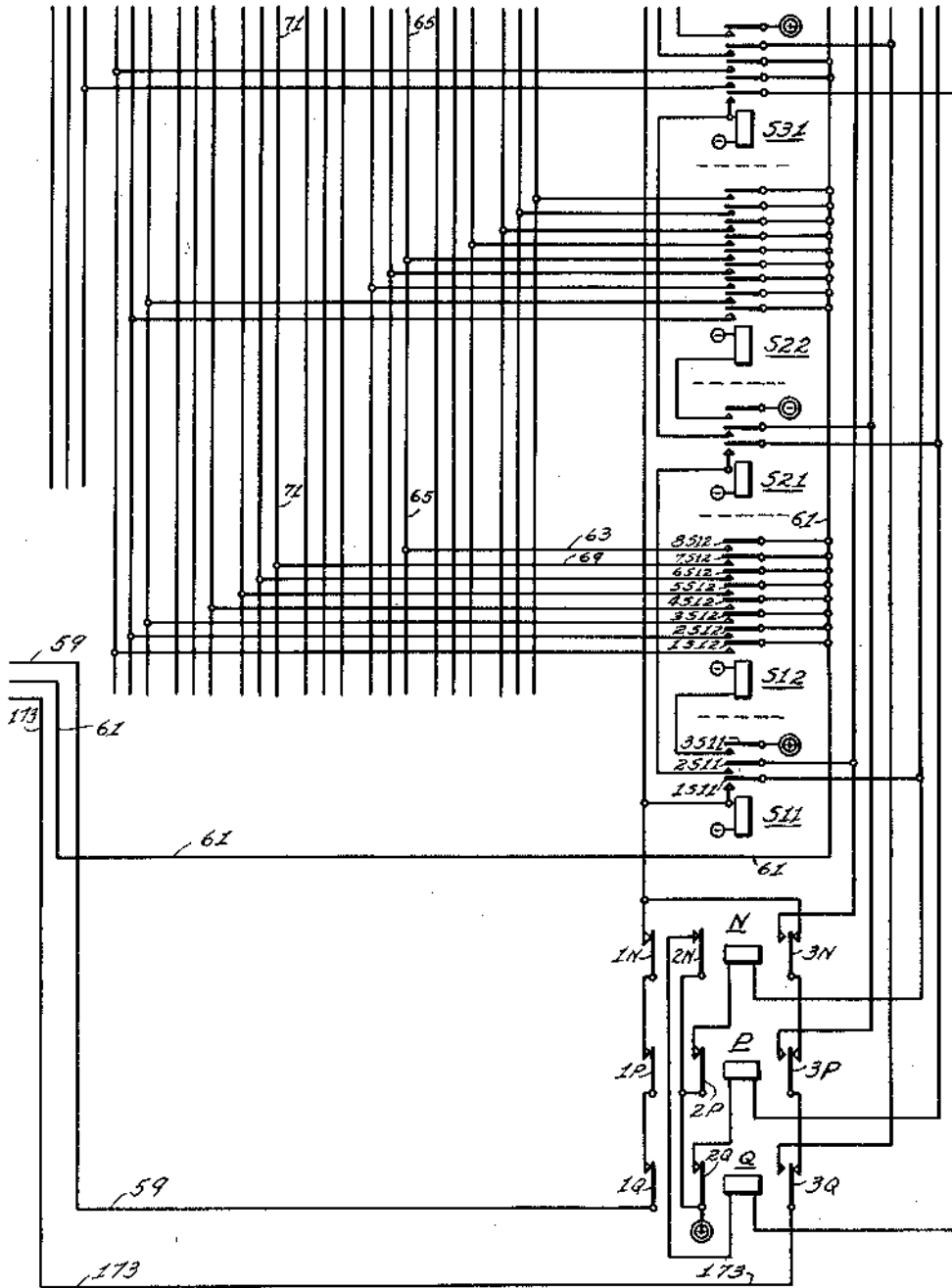

WITNESSES:  
*James F. Young*  
*Wm. Diamond*

Fig. 12.

INVENTORS  
 Edward U. Condon, Gerold L. Tawney,  
 and Willard A. Derr.  
 BY  
*F. W. Syle*  
 ATTORNEY

# UNITED STATES PATENT OFFICE

2,215,544

## MACHINE TO PLAY GAME OF NIM

Edward U. Condon, Edgewood, and Gereld L. Tawney and Willard A. Derr, Wilkensburg, Pa., assignors to Westinghouse Electric & Manufacturing Company, East Pittsburgh, Pa., a corporation of Pennsylvania

Application April 26, 1940, Serial No. 331,784

17 Claims. (Cl. 273-130)

Our invention relates to control apparatus and has particular relation to electrical apparatus for automatically making the moves of one party in a game between two opponents.

5 Nim is played by two opponents with a plurality of sets of like elements. There may be any arbitrary number of elements in each set but it is preferred that no two sets shall have the same number. The players make their moves alternately as in checkers and each player, in his turn, may remove any number of elements from any one set. A player may remove elements from different sets during different moves. The player who removes the last element leaving no elements to be removed by his opponent is the winner of the game.

10 Nim is to a certain extent similar to checkers. The latter game can be won or lost during the first few moves. Unless the elements are initially arranged in a winning combination, Nim can be won by the player making the first move. Mathematical analysis reveals that to win at Nim, a player must first express the number of elements in each set as a sum of different integral or zero powers of 2. He must then establish and maintain an array of sets such that all integral or zero powers of 2 contained in the numbers of elements of the sets are present in an even number of sets. The number of elements removed by the other player in his turn from one set contain either one power of 2 or several different powers of 2, and therefore, there remain one or more powers of 2 in an odd number of sets after the latter moves. The second player cannot therefore establish a winning combination once it has been established by his opponent and the latter can always reestablish the winning combination.

15 For a better understanding of Nim and the manner in which it is played, we may consider an example. Assume that originally there are three sets of like elements; 9 elements in set No. 1; 7 elements in set No. 2, and 5 elements in set No. 3. In playing the game, each player, in his turn, may remove any number of elements from set No. 1, set No. 2, or set No. 3. He may, for example, remove 6 elements from set No. 1 in making his first play and after the other player moves, he may remove any number of elements from the same or another set, say set No. 3. The player removing the last element is the winner. To make certain of winning the game, the first player must remove a number of elements so that powers of 2 remaining in set No. 1, set No. 2, and set No. 3 after his move are each present in an even number of sets.

Initially the array of sets may be analyzed as follows:

$$\begin{array}{r} \text{Set \#1-9=8+1=2}^3 \quad +2^0 \\ \text{Set \#2-7=2}^2+2^1+2^0 \\ \text{Set \#3-5=2}^2 \quad +2^0 \end{array}$$

20 The zero power of 2 is present in all three sets. The first power of 2 is present only in set No. 2. The second power of 2 is present in set No. 2 and set No. 3. The third power of 2 is present in set No. 1. The first player can assure himself of winning the game by removing sufficient elements from set No. 1 to balance the odd  $2^1$  in set No. 2. Accordingly, he removes 7 elements from set No. 1, leaving two elements. Set No. 1 now contains only the first power of 2; set No. 2 contains the second power of 2, the first power of 2 and the zero power of 2; and set No. 3 contains the second power of 2 and the zero power of 2. It is seen that each power of 2 contained in the sets is present in two sets. After the first player has made the play just suggested, the second player cannot win the game regardless of what play he makes unless the first player fails to maintain the winning combination.

25 For example, if the second player removes one element from set No. 2, leaving six elements in this set, the first player should remove one element from set No. 3, leaving the combination set No. 1 two elements, set No. 2 six elements, and set No. 3 four elements. If the second player now removes another element from set No. 2, the first player should remove one element from set No. 1, leaving set No. 1 one element, set No. 2 five elements, and set No. 3 four elements. If the second player now removes another element from set No. 2 the first player removes the remaining element from set No. 1 leaving set No. 2 four elements and set No. 3 four elements. If the second player now removes an element from set No. 3, the first player removes an element from set No. 2, leaving 3 elements in each of the two sets. If the second player now removes still another element from set No. 3, the first player removes an element from set No. 2 and on the removal of a further element by the second player from set No. 3, the first player removes still another element from set No. 2 leaving one element in each set. Whichever element the second player removes, the first player necessarily removes the last element.

It is an object of our invention to provide an electrical system for playing Nim.

Another object of our invention is to provide

an electrical system which shall perform the plays of one player in the game of Nim.

A further object of our invention is to provide electrical apparatus for playing Nim wherein the initial array of elements shall be such that the player opposing the apparatus shall be capable of winning if he makes a series of correct moves.

More concisely stated, it is an object of our invention to provide a device for playing Nim and for displaying the arrays and moves while the game is being played.

In accordance with our invention, we provide a system in which the like elements used in playing Nim are a plurality of sets of lamps. Any combination of sets may be established by extinguishing certain of the lamps in each of the sets. The lamps are connected in circuits which are controlled by manually operable switches. A player may in his turn extinguish any desired number of lamps in any one set only by operating a switch. Thereafter he may operate another switch, causing certain additional lamps in one of the sets to be extinguished automatically. The operations may be repeated by the player until either he or the machine extinguishes the last lamps. Preferably the number of lamps initially energized is such that the player who operates the control element may win, if, in his first move, he establishes a winning combination and if he maintains the winning combination when making the following moves in his turn. However, if the player makes one incorrect move, the machine sets up the winning combination and thereafter the player is certain to lose.

The novel features that we consider characteristic of our invention are set forth with particularity in the appended claims. The invention itself, however, both as to its organization and its method of operation, together with additional objects and advantages thereof, will best be understood from the following description of a specific embodiment when read in connection with the accompanying drawings in which:

Figure 1 is a view in perspective of a structure in accordance with our invention;

Fig. 2 is a view in side elevation of the structure shown in Fig. 1;

Fig. 3 is a view in rear elevation of the structure shown in Fig. 1 with the cover removed in part; and

Figs. 4 to 12, together, constitute a diagrammatic view showing the electrical circuit used in the practice of our invention.

#### THE MECHANICAL STRUCTURE

The apparatus shown in the drawings comprises a casing 13 having the form of a desk. The casing comprises a vertical chamber 15 from the front surface of which communicating chamber 17 extends. The latter chamber has a height somewhat greater than half the height of the chamber 15. The top 19 of the chamber 17 is at a slight angle to the horizontal and constitutes a platform similar to the working surface of a desk. In the surface 21 of the chamber 15, above the top 19, a plurality of lenses 23 are arranged in vertical rows. Behind each row the lamps used in the playing of Nim are mounted.

Specifically our invention is shown as applied in a system in which there are four sets of elements and a maximum of seven elements in any set. There are accordingly four rows of lamps with seven lamps in each row. The rows are designated, respectively, as *a*, *b*, *c* and *d*, and the

individual lamps in each row are identified by the letter of their row and a number, depending on their position with reference to the top of the row. Thus the lamps in row *a* are *a1*, *a2*, *a3*, *a4*, *a5*, *a6* and *a7* from top to bottom; the lamps in row *b* from top to bottom are *b1* to *b7*; the lamps in row *c* from top to bottom are *c1* to *c7*; and the lamps in row *d* from top to bottom are *d1* to *d7*.

The surface 21 of the chamber 15 is also provided with short slots 25, 27 and 29 behind which counters 30 are disposed. The counter on the extreme right FWC indicates the number of games won by the player, the counter in the center MWC indicates the number of games won by the apparatus and the counter on the extreme left TP indicates the total number of games played.

Just above the platform 19, the surface 21 of the chamber 15 is provided with an opening 31 partially enclosed in its lower end by a semi-cup 33 into which a token drops when a player wins a game. The tokens are stacked in a channel 35 extending at a slight angle to the vertical from the top of the chamber 15 to the opening 31 and are released one at a time when a relay SG is actuated and actuates the token release device TRL.

Near the top of the surface 21 there is an elongated slot 37 in which a plaque having printed thereon the instructions for operating the apparatus is disposed. A cube 39 is supported from the top of the chamber 15 on legs 41. In each of the vertical faces of the cube 4, rows of lamps 43 are disposed. The lamps in each of the rows in the faces of the cube are connected in parallel with correspondingly positioned lamps. The cube 39, therefore, displays in all directions and at all times the same pattern as the lamps in the rows *a*, *b*, *c* and *d* behind the lenses 23. The lamps behind the lenses are used in playing Nim with the apparatus, and the lamps on the cube indicate the progress of the same as it is being played.

A plurality of relays for performing the various operations in playing the game are disposed on a frame 45 in the chamber 15. The relays and the lamps may be energized from the usual commercial alternating current supply through a plurality of power supply units, each consisting of a transformer (not shown) and a dry rectifier 47. The power supply units are disposed in the shorter chamber 17 below the platform 19.

From the top of the chamber 15 a pair of lamps P and M extend. The lamp P is green and is energized when the player is making a move. The lamp M is red and is energized when the apparatus is making a move. When the apparatus move has been completed, the lamp M is extinguished and the lamp P is energized.

#### The circuit

The lamps *a1* to *a7*, *b1* to *b7*, *c1* to *c7*, and *d1* to *d7* used in playing the game are connected in circuits which are controlled by relays A1 to A7, B1 to B7, C1 to C7 and D1 to D7, respectively. The relays are provided with back contacts 1A1 to 1A7, 1B1 to 1B7, 1C1 to 1C7, and 1D1 to 1D7 which normally maintain the lamp circuits closed. The relays A1 to A7 are controlled by a master relay A, the relays B1 to B7 by a master relay B, the relays C1 to C7 by a master relay C, and the relays D1 to D7 by a master relay D. The master relays are actuated by pushbuttons PA, PB, PC and PD, respectively,

which are disposed in a row in the platform 19 so as to be conveniently operated by a player. When a player operates one of the pushbuttons PA to PD, he extinguishes the energized lamp 5 having the lowest subscript in the corresponding row. Successive operations of the same pushbutton extinguish other lamps in the same row in succession. Once a player has actuated a pushbutton in any row, the pushbuttons corresponding to the other rows are locked out by the 10 operation of relays AL, BL, CL and DL, respectively. The player may, however, actuate another pushbutton MTR which energizes a relay TR so that the apparatus operates automatically 15 to extinguish lamps in one of the rows, thus preparing the apparatus for another play by the player.

At the beginning of the game not all of the lamps in all of the rows are energized. Certain 20 of the relays A1 to D1 are initially actuated so that a selected combination is displayed. The apparatus may be designed so that any number of the combinations that can be made with four groups of seven elements each can be displayed. 25 However, space limitations do not permit the use of all of the combinations, and, therefore, in the practice of our invention only a selected number of combinations are used. In the apparatus shown in the drawings, the combinations set forth 30 in the following table are displayed in sequence.

Set up	Row a	Row b	Row c	Row d
35 Combination #1.....	7	6	3	4
Combination #2.....	3	4	7	5
Combination #3.....	2	7	5	3
Combination #4.....	6	5	4	3
Combination #5.....	3	2	4	7
Combination #6.....	2	7	5	4
Combination #7.....	3	7	6	1
Combination #8.....	6	2	1	7
40 Combination #9.....	2	5	6	4

The sequential display of the combinations is controlled by the relays S11, S12, S21, S22, S31, S32, S41, S42, S51, S52, S61, S62, S71, S72, S81, S82, and S91, S92. The combinations are permuted 45 by the operation of relays N, P and Q.

The performance of the apparatus is dependent on the automatic analysis of the number of the energized lamps in each row into sums of zero or integral powers of 2. Since the maximum number of lamps that may be energized in any row is 7, the only powers of 2 to be considered are the zero power, the first power, and the second power. The relays AZ, BZ, CZ and DZ are actuated when the numbers of energized lamps in the corresponding rows a, b, c and d, respectively, contain a zero power of 2; the relays AF, BF, CF and DF are actuated when the numbers of energized lamps in the rows a, b, c and d, respectively contain a first power of 2; and the relays AS, BS, CD and DS are actuated when the numbers of energized lamps in the rows a, b, c and d, respectively, contain a second power of 2. To properly play the game, the apparatus must also 65 determine whether any power of 2 is contained in the number of energized lamps in an even number or an odd number of rows. For this purpose, the relays EZ, EF and ES are provided. These relays are energized if the zero power, the first power and the second power, respectively, are contained in the number of energized lamps in an even number of rows. The relays are also energized if the corresponding power is entirely absent from the number of lamps in all of the 70 rows.

When the transfer button MTR is actuated and actuates the relay TR, the apparatus may operate in two different ways. If all of the powers of 2 contained in the numbers of lamps in the rows are present in an even number of rows, the machine performs a random operation. In such a case the relay RM is actuated and then the relay RMS is actuated. This is followed by the actuation of one of the relays AR, BR, CR, DR, which selects the row of lamps a, b, c or d, 10 respectively, in which the number of energized lamps is a maximum. A certain number of the lamps in the selected row is then extinguished by the cooperation of the relays R1, R2 and R3, the relays X, Y and Z, the relays RX and RY, and 15 the relays RC1, RC2 and RC3. The number of lamps which is extinguished is determined by the sequential operation of the relays R1, R2 and R3, relay R1 being actuated when the apparatus makes the first random move; R2 being actuated 20 when the apparatus makes the second successive random move, and R3 being actuated when the apparatus makes the third successive random move. R1 deenergizes one lamp, R2 two and R3 three. If further successive random moves are 25 required, the sequence is repeated.

If the powers of 2 contained in the numbers of lamps in the different rows are not present in an even number of rows when button MTR is operated, cooperation of the transfer relay TR with 30 the relays EZ, EF, ES results in actuation of the relays CM and CMS. In such a case the player has manifestly made an incorrect move and the relays CM and CMS now produce a sequence which results in a correct move so that after one incorrect move by the player, the apparatus is assured of winning the game. In such a case, the correct row is selected by the cooperation 35 of relays CM and CMS and relays AZ, AF, AS, BZ, BF, BS, CZ, CF, CS, DZ, DF, DS, which in turn control relays ARZ, BRZ, CRZ and DRZ, AR, BR, CR and DR, which correspond to the lamps a, b, c and d, respectively.

The transfer operation is controlled by relay TR and relay T10 which are actuated when relay T9 is actuated. Relays T1 to T9 are actuated 45 subsequently after the transfer relay TR is energized. The former relays control the red lamp M. The lamp M is energized when the transfer operation begins and is gradually deenergized until the transfer operation is completed. The relay T10 cooperates with the interlocked relays P1 and P2 which initiate the actual extinction of lamps. After the game is completed, the resetting for a new game takes place 50 by the operation of the relay RE. Relay ER deenergizes transfer relay TR when the relay RM is set for a random operation involving the extinguishing of more energized lamps than are available. For example, if only one lamp in each row 60 is energized and relay RM is set to extinguish three lamps, relay ER deenergizes relay TR. As indicated, relays CMS, RMS, T1 to T9, P1, P2 and P3 are slow to release but pick up instantaneously.

#### Player makes first move 65

To illustrate the operation of the apparatus, we shall trace the performance of the machine when a game is being played therewith. When the power supply switch (not shown) for the apparatus is closed, all of the lamps a1 to d1 are energized. In addition, relays AS, BS, CS and DS are energized. Relay AS is energized through contact 2A4 and conductor 51, relay BS is energized through contact 2B4 and conductor 53, re- 75

lay CS is energized through contact 2C4 and conductor 55, and relay DS is energized through contact 2D4 and conductor 57. Because relays AS to DS are energized, relay ES is energized. The circuit for relay ES extends through contacts 3AS, 3BS, 4CS and 3DS. Contact 3ES is, therefore, pulled up and relay S11 is actuated through conductor 59 and contacts IQ, IP and IN. Relay S11 closes contact 3S11, actuating relay S12. Relay S12 closes contacts 1S12 to 8S12, setting up a playing combination on the apparatus. All of the contacts 1S12 to 8S12 are polarized positive from contact 2RE through conductor 61. Contact 8S12 closes a circuit extending through conductor 63, conductor 65, conductor 67, relay B1, actuating the relay, opening contact 1B1 and extinguishing lamp d1. The relay is locked in through contact 3B1.

Contact 7S12 closes a circuit extending through conductor 69, conductor 71, conductor 73, relay C1, extinguishing lamp c1. In an analogous manner, contacts 6S12, 5S12 and 4S12 extinguish lamps c2, c3 and c4. Contacts 3S12, 2S12 and 1S12 extinguish lamps d1 to d3, respectively. The display of lamps then corresponds to combination 1 on the chart. There are seven energized lamps in row a, six energized in row b, three energized in row c, and four energized in row d.

Relay N is, moreover, actuated through contact 2P, conductor 75, contact 1S11 and relay S11.

Relays AZ and AF are now actuated in addition to AS. Relay AZ is energized through contact 1AN and conductor 77. Relay AF is energized through contacts 2A1 and conductor 79. Relay BF is energized through contact 2B2 and conductor 81. Relay CS is now deenergized because contact 2C4 is open. Relay CF is energized through front contact 2C4, contact 2C6, and conductor 83. Relay CZ is energized through contact 1CN and conductor 85.

#### Player moves

With the apparatus in the condition just described, the player elects to operate button PA. Relay A is now actuated in a circuit extending from the back contact 1RMS, contact 1CMS, conductor 87, back contact 2DL, back contact 3CL, back contact 2BL, conductor 89, pushbutton PA, conductor 91, relay A. Relay A1 is now actuated through contacts 4A2, 4A4, 4A6, 2AN and 2A and lamp a1 is extinguished. Relay AL is also actuated in a circuit extending from positive conductor 83, through contact 1A and conductor 93. Relay AL locks out the other rows of lamps b, c and d and prevents the player from extinguishing lamps in the other rows, since by the rules of the game he is permitted to extinguish the lamps in only one row in making a play. When key PA is released, relay A is deenergized and relay AN is energized in a circuit extending through contact 3A, contacts 5A1, 5A2 and conductor 95. AZ is then deenergized because contact 1AN is opened. AZ is deenergized now to denote that the row contains no zero power.

Since the number of zero powers of 2 which are now contained in the numbers of energized lamps in the different rows is odd, the relay EZ is deenergized. This relay was originally energized in a circuit extending through front contact 2AZ, back contact 2BZ, front contact 2CZ, and back contact 2DZ. Since front contact 2AZ is opened, relay EZ is now deenergized.

One keying operation is now completed. The player could elect to stop his play at this point

but he continues and operates key PA again. In this case, relay A is again actuated and this time relay A2 is actuated through contact 2A, front contact 2AN, back contact 4A7, back contact 4A5, back contact 3A3, and contact 4A1. Lamp a2 is, therefore, extinguished. Moreover, relay AF, which was originally maintained actuated through the back contact 2A2, is now deenergized since this contact is opened. There is, moreover, now an even number of rows, the energized number of lamps of which contain a first power of 2, and, therefore, relay EF is actuated. This relay is actuated in a circuit extending through back contact 3AF, front contact 4BF, front contact 3CF, and back contact 3DF.

When the player now releases button PA, relay A is deenergized and relay AN is deenergized because contact 5A2 is open. Relay AZ is now energized because contact 1AN is closed and relay EZ is energized because front contact 2AZ is again closed.

The player now elects to again press button PA. This time relays A and A3 are energized in succession and lamp a3 is extinguished. When the button PA is released, relay A is deenergized and relay AN is energized through back contact 3A, contact 4A3, and contact 5A4. Relays AZ and EZ are then deenergized in succession.

The player now again actuates button PA. Thus time relays A and A4 are actuated in succession and lamp a4 is extinguished. Now relay AS is deenergized because back contact 2A4 is opened, and because front contact 2A4 is closed relay AF is energized through contact 2A5, contact 2A6, and conductor 79. The operation of relays AS and AF is in accordance with the condition of lamps a. There are now only 3 a lamps energized and, therefore, there is no longer a second power contained in the number of energized a lamps, but there is a first power. Next, relay ES is energized because the number of rows of lamps in which the second power of 2 is included in the number of energized lamps is even. The circuit for relay ES extends through back contact 3AS, front contact 4BS, back contact 3CS and front contact 3DS. Moreover, relay EF is deenergized because front contact 3AF is opened. When the button PA is now released, relays A and AN are successively deenergized and in succession relays AZ and EZ are energized.

The player again operates button PA. This time relays A and A5 operate, lamp a5 is extinguished, and on the release of the button, relay A is deenergized, relay AN energized and relays AZ and EZ are deenergized in succession.

A further operation of the button PA results in the sequence of operations, actuation of relays A and A6, extinction of lamp a6, deenergization of relay AF, energization of relay EF, release of button, deenergization of relays A and AN, energization of relay AZ and relay EZ. The player has now elected to have the extinguishing of the above mentioned lamps constitute his move. He has extinguished six lamps so that only one lamp remains energized in row a. The number of lamps are now as follows:

Row a 1 =  $2^0$   
 Row b 6 =  $2^2 + 2^1$   
 Row c 3 =  $2^1 + 2^0$   
 Row d 4 =  $2^2$

Since the powers of 2 contained in the numbers of energized lamps are now present in an even number of rows, the player has made a correct

move. The relays which are now energized to indicate the powers of 2 which are present in the various rows are AZ, BF, BS, BN, CA, CF, DS, EZ, EF and ES.

#### Apparatus makes a play

The player now operates the transfer key MTR. The operation of the key closes a circuit through relay TR extending through back contact IRMS, contact ICMS, conductor 87, back contact IBL, front contact 3AL, conductor 97, button MTR and conductor 99. Relay T1 is now energized through contact 2TR, conductor 101, and back contact IT10. Following relay T1, relays T2 to T9 are energized in succession, relay T2 being energized through contact IT1, relay T3 being energized through contact IT2, etc. A negligible length of time elapses before relay T9 is energized. As relays T1 to T9 are energized, the resistances 103 in series with the lamp M are successively short circuited.

The actuation of relay TR also produces actuation of relay RM which is the relay for causing the apparatus to make a random play. The relay RM is actuated in a circuit extending through contact 2TR, conductor 101, front contact 2ES, front contact 2EF, front contact 2EZ and contact 2CMS. Relay BR is also actuated on the actuation of relay TR. The circuit for relay BR extends through contact ITR, conductor 105, back contact IDR, back contact ICR, back contact IBR, back contact IAR, conductor 107, front contacts IES, IEF and IEZ, conductor 109, back contact 2AS, front contact 2BS and conductor 111.

Relay RMS is energized through contact 2RM of relay RM. Relay R1 is energized in a circuit through contact 3RMS, conductor 113, and back contacts IZ, IY and IX. Relay X is now energized through conductor 115, contact 2Y, relay X, contact IR1 and relay R1. After relay T9 operates, relay T10 operates because its circuit is closed through contact IT9. The operation of T10 opens back contact 2T10 and closes front contact 2T10. The lamp P is, therefore, extinguished and lamp M is brightly energized, indicating that a transfer play is taking place. The back contact IT10 is, moreover, opened, and this opens the circuit through relay T1 so that T1 is deenergized and contact IT1 opens after a short time delay. The opening of contact IT1 is followed by the opening of contacts IT2 to IT9 and the gradual deenergization of relays T2 to T9. Lamp M is, therefore, gradually dimmed.

The release of T9 completes a circuit for energizing relay P1. The circuit for relay P1 extends through contact 2TR, conductor 101, front contact IT10, back contact IT9, conductor 117, and back contact 3Pa. Actuation of P1 is followed by actuation of P2 through front contact 2P1. The circuit through relay P1 is now opened because back contact 3P2 is opened. However, contact 2P1 remains actuated. Therefore, relay B is actuated. This relay is in a circuit extending through contact 2TR, conductor 101, front contact IT10, back contact IT9, conductor 117, front contact 3P2, contact IP1, conductor 119, contact IRM, conductor 121, contact 3BR, conductor 123, contact IBS, conductor 125 and conductor 127. Relay B2 is, therefore, energized in a circuit extending through contact 2B, front contact 2BN, back contact 4B7, back contact 4B5, back contact 3B3, and contact 4B1. Lamp b2 is, therefore, extinguished and relay BF is deenergized because back contact 2B2 is opened. Since

the number of rows with a first power of 2 is now odd, relay EF opens.

After contact IP1 of relay P1 opens, relay B is deenergized. Relay RC1 is now closed in a circuit extending through back contact 2P1, contact 2P2, conductor 129, contact 5RM, conductor 131, back contact IRY and back contact IRX. Moreover, relay P2 is deenergized because front contact 2P1 is opened but the contacts of relay P2 are not actuated for a short interval of time.

Because front contact 3B is now open, the circuit for relay BN is opened and this relay is deenergized. By the actuation of relay RC1 the holding circuit of relay RM is opened at contact 3RC1. The holding circuit extends through contact IRE, conductor 133, contact 3RC1, conductor 135, contact 3R1, conductor 137 and contact 3RM. Because contact IBN is closed, relay BZ is actuated. Because contact 2RM opens relay RMS is deenergized and after a predetermined delay, its contacts open. Because contact 4RM is opened, transfer relay TR is deenergized.

Sufficient time has now elapsed so that the contacts of relay P2 drop out. Moreover, because front contact 2BZ closes, relay EZ becomes deenergized, as is necessary, since the zero power of 2 is now present in an odd number of rows. Relay RMS has not as yet dropped out and RX is energized through front contact IRMS, conductor 139, contact 2RY, contact IRC1 and relay RC1. Because contact 2TR is opened, the holding circuit for relay T10 through front contact IT10 is opened and T10 is deenergized. Relay BR is deenergized because contact ITR is opened. Since front contact 2T10 is opened and back contact 2T10 is closed, lamp M is extinguished and lamp P is energized.

Sufficient time has now elapsed so that the contacts of relay RMS drop out. Because front contact IRMS opens, relay RX drops out and relay RC1, which was sealed in through front contact IRMS, also drops out. The random move of the apparatus is now at an end and the following relays are now energized: AZ, BZ, BS, CZ, CF, DS, ES, X and R1.

#### Player makes second move

The player elects row c for a second move. The operation of the relays and the contacts is analogous to the operation during the first move, but in this case, the relays of row c are involved. The operator closes button PC and relays C5 and CL are energized. Relay C5 extinguishes lamp c5 and relay CL locks out the other push-buttons PA, PB and PD. When button PC is released, relay C is deenergized, relay CN energized, relay CZ deenergized, and relay EZ energized. Another operation of button PC produces the sequence: C energized, C6 energized, lamp c6 deenergized, relay CF deenergized, and relay EF energized. On the release of button PC, relay C is deenergized, relay CN deenergized, relay CZ energized and relay EZ deenergized. Another operation of button PC causes relay C to be energized, relay C7 to be energized and lamp c7 to be deenergized. The release of button PC causes relay C to be deenergized, relay CN to be energized, relay CZ to be deenergized and relay EZ to be energized.

All of the lamps in row c are now extinguished. The combination of energized lamps is now as follows:

Row a	1=	2 <sup>0</sup>
Row b	5=2 <sup>2</sup>	+2 <sup>0</sup>
Row c	0=	
Row d	4=2 <sup>2</sup>	



There are an even number of rows containing all powers of 2 and, therefore, the player has made a correct move, and when the apparatus moves, it is again to make a random move. The following relays are energized: AZ, BZ, BS, DS, CL, EZ, ES, EF, RI, X.

*Apparatus makes a second random move*

The player now again operates the transfer button MTR. Relay TR is energized in the same manner as before, as are relays T1 and RM. Relay BR is energized in a circuit extending through contact 1TR, conductor 105, back contact 1DR, back contact 1CR, back contact 1BR, back contact 1AR, conductor 107, front contact 1ES, front contact 1EF, front contact 1EZ, conductor 109, back contact 2AS, front contact 2BS and conductor 111. Following the actuation of relay T1, relays T2 to T10 are sequentially energized. Relay RMS is energized through contact 2RM. Because contact 3RMS is closed, relay R2 is energized in a circuit through contact 3RMS, conductor 113, back contact 1Z, back contact 1Y, front contact 1X, and contact 2R1. Relay CL is deenergized because back contact 1RMS is opened. When relay T10 is energized, lamp P is deenergized and lamp M is energized through front contact 2T10. Relays T1 to T9 are next sequentially deenergized with a predetermined delay and the lamp M dims as more and more resistance is introduced into the lamp circuit.

Eventually, front contact 1T9 opens and back contact 1T9 closes. At this point relays P1 and P2 are energized in the same manner as in the first transfer move. After P2 is energized, P1 is deenergized, and after a predetermined time its contacts drop out. However, before this occurs, relay B is energized. The energizing circuit extends through contact 2TR, conductor 101, front contact 1T10, back contact 1T9, conductor 117, front contact 3T2, contact 1P1, conductor 119, contact 1RM, conductor 121, contact 3BR, conductor 123, contact 1BS, conductor 125, and conductor 127. Relay B3 is now energized through contact 2B, back contact 2BN, back contact 4B5, back contact 4B3 and front contact 4B2. Lamp b3 is now extinguished.

Sufficient time has now elapsed so that front contact 2P1 of relay P1 opens and back contact 2P1 closes. Relay RC1 is, therefore, energized through back contact 2P1, contact 2P2, conductor 120, contact 5RM, conductor 131, back contact 1RY and back contact 1RX. Relay P2 is deenergized by the opening of front contact 2P1, and after a predetermined time, its contacts drop out. Moreover, relay BN is energized through contact 4B3 in the usual manner. Relays BZ and EZ become deenergized as has been explained several times above.

Now sufficient time has elapsed so that the contacts of relay P2 open. Relay P1 is now again energized in the circuit which has been traced through contact 2TR. It is to be noted that relay RM does not become deenergized after the lamp b3 is extinguished, because it is sealed in a circuit extending through contact 1RE, conductor 133, contact 3RC2, conductor 141, contact 3R2, conductor 137, and contact 3RM. When relay P1 is energized, relay P2 is energized and thereafter relay P1 is deenergized and after a predetermined time interval its contacts open. However, before this occurs, relay B is energized, relay B4 is energized, and lamp b4 is extinguished. Relay BS is now deenergized and relay BF is

energized in circuits analogous to those traced with reference to the lamps of row a.

Sufficient time has now elapsed so that relay P1 is deenergized. Relay ES is deenergized because front contact 4BS opens. Relay EF is deenergized because back contact 4BF opens. When front contact 2P1 opens, relay P2 is deenergized, and after a predetermined time, its contacts drop out. Relay B opens because contact 1P1 opens and relay RC2 closes through back contact 2P1, contact 2P2, conductor 129, contact 5RM, conductor 131, back contact 1RY, front contact 1RX and contact 2RC1. The deenergization of relay B is followed by the deenergization of relay BN.

Relays BZ and EZ close in sequence in a manner explained with reference to the relays of row a. On the deenergization of relay RM, relay RMS is deenergized and after a predetermined delay, its contacts are opened. Relay TR, which was sealed in through contacts 3TR, 4RM, conductor 143, contact 1ER, conductor 133 and contact 1RE, is deenergized because the holding circuit for relay TR is broken when contact 3RC2 opens and relay RM opens. Relay RY is energized through front contact 1RMS, which has not as yet opened, conductor 139, contact 1RC2, and relay RC2. Relay T10, which was locked in through contact 2TR, now is deenergized. Relay BR, which was locked in through contact 1TR, also opens.

Relay RX was energized through contact 2RY and it is deenergized when this contact opens. Relay RC1, also locked through contact 2RY, also opens. When relay T10 is deenergized, lamp M is deenergized and lamp P is energized.

Now sufficient time has elapsed and relay RMS drops out. The holding circuit for relay RC2 was closed through front contact 1RMS and, therefore, this relay becomes deenergized. RY is also deenergized for the same reason. Relay Y, on the other hand, is energized through conductor 115, contact 2Z, conductor 145, contact 1R2, and relay R2. Because contact 2Y now opens, relay R1, sealed in through contact 1R1, conductor 147, relay X, contact 2Y and conductor 115, opens. For the same reason, relay X is also deenergized. The second move by the machine is now complete. The relays which remain energized are AZ, BZ, BF, DS, DN, EZ, R2 and Y.

*Player makes third play*

On the third play the player operates key PD only once. Relays D, D4 and DL are energized in the manner explained with reference to the other rows of lamps. Similarly lamp d4 is deenergized, relay DS is deenergized, relay DF is energized, and relays ES and EF are energized. On the release of button PD, relays D and DN are deenergized in sequence and relay DZ is energized and is followed by the deenergization of relay EZ. The relays which now remain energized are AZ, BZ, BF, DZ, DF, DL, EF, ES, R2, and Y. The array of rows is now as follows:

Row a 1 = 2<sup>0</sup>  
 Row b 3 = 2<sup>1</sup> + 2<sup>0</sup>  
 Row c 0  
 Row d 3 = 2<sup>1</sup> + 2<sup>0</sup>

The zero power of 2 is now contained in the number of energized lamps in an odd number of rows and, therefore, the player has made an incorrect move.

*Apparatus makes third move—a correct move*

On the operation of button MTR, the apparatus makes a correct move since the player has moved incorrectly. The operation of button MTR results in the energization of relay TR and relays T1 to T10 in the manner explained with reference to the other moves. Now, however, relay CM is energized in a circuit extending through contact 2TR, conductor 101, front contact 2ES, front contact 2EF, back contact 2EZ, contact 2RMS, and conductor 149. Relay ARZ is now also energized in a circuit through contact 1TR, conductor 105, back contact 1DR, back contact 1CR, back contact 1BR, back contact 1AR, conductor 107, front contact 1ES, front contact 1EF, back contact 1EZ, conductor 151, front contact 1AZ, and conductor 153. The closing of contact 2CM results in the energization of relay CMS. Because contact 1ARZ is closed, relay AR is energized. The energizing circuit for relay AR is the same as for relay ARZ, except that it extends through contact 1ARZ from conductor 153. When contact 1CMS opens, the holding circuit for relay DL, through contact 2DL, conductor 87, contact 1CMS, back contact 1RMS, is opened and relay DL is deenergized. When relay T10 is energized, the lamp P is deenergized and lamp M is energized. Relays T1 to T9 now become deenergized in sequence, and with a certain time delay and because of the addition of resistance in the lamp M circuit, lamp M dims. When relay T9 drops out, relay P1 is energized through contact 2TR, conductor 101, front contact 1T10, back contact 1T9, conductor 117, and back contact 3P2. Relay P2 is next energized and because back contact 3P2 now opens, relay P1 is deenergized and drops out after a certain time interval. However, in the meantime relay A is energized in a circuit through contact 2TR, conductor 101, front contact 1T10, back contact 1T9, conductor 117, front contact 3P2, contact 1P1, conductor 119, contact 1CM, conductor 155, contact 2AR, conductor 91, and conductor 157. Relay A1 now is energized, deenergizing lamp a1.

Now sufficient time has elapsed so that relay P1 drops out. P2 is then deenergized but does not as yet drop out. However, the circuit through relay A is opened at contact 1P1 and relay A is deenergized. Relay AN is energized, relay AZ is deenergized, and relay EZ is energized in the manner which has been explained.

At this time relay P2 drops out and the holding circuit for relay CM, through contact 3CM, contact 3P1, conductor 133, and contact 1RE, is opened, so that relay CM is deenergized. Relay TR which was locked in through contact 3TR and contact 4CM is deenergized by the opening of contact 4CM. Relay CMS is deenergized by the opening of contact 2CM and it begins to drop out. While relay CMS is dropping out, relay T10, which was sealed in through contact 2TR, becomes deenergized. Relay AR, which was sealed in through contact 1TR, conductor 105, back contact 1DR, back contact 1CR, back contact 1BR, and front contact 1AR, is deenergized because its sealing circuit is open at 1TR. Relay ARZ, which was sealed in the same circuit as relay AR through contact 1ARZ, is also deenergized. The dropping out of contact T10 results in the deenergization of lamp M and the energization of lamp P. Relay CMS drops out after lamp P is energized.

The relays which now remain energized are AN, BZ, BF, DZ, DF, EZ, EF and ES. Since there

now remain three energized lamps in row b and three energized lamps in row d, the apparatus has clearly made a correct move.

*Player makes fourth move—an incorrect move*

The player can no longer make a correct move. He now elects to operate pushbutton PB twice. The first operation results in the deenergization of lamp b3, the energization of relay BN and the deenergization of relays BZ and EZ. The second operation results in the deenergization of lamp b6, the deenergization of relays BF, EF and BN, and the energization of relays BZ and EZ. The relays which are now energized are BL, BZ, DZ, DF, EZ and ES. There are now three lamps in row d and one lamp in row b.

*Apparatus makes fourth move—a correct move*

The operation of the transfer button MTR now results in the energization of relays TR, T1 to T10, CM and CMS in the manner explained. Relay DR is energized in the circuit extending through contact 1TR, conductor 105, back contact 1DR, back contact 1CR, back contact 1BR, back contact 1AR, conductor 107, front contact 1ES, back contact 1EF, conductor 159, back contact 2AP, back contact 2BF, back contact 2CF, front contact 2DF, and conductor 161. Relay BL is deenergized because contact 1CMS is opened.

When front contact 1T10 closes, relay T1 is deenergized and relays T1 to T9 drop out in sequence, each with a predetermined time delay. When relay T9 drops out, relays P1 and P2 are closed in sequence and relay P1 is thereafter deenergized but does not drop out. Relay D is now energized through contact 2TR, conductor 101, front contact 1T10, back contact 1T9, conductor 117, front contact 3P2, contact 1P1, conductor 119, contact 1CM, conductor 155, contact 2DR and conductor 163. Relay D5 is now energized and lamp d5 is deenergized. Thereafter contact 1P1 opens, relay D is deenergized, relay DN is energized and relays DZ and EZ are deenergized in sequence. Now relay P2 drops out.

However, relay CM remains energized through contact 2TR, conductor 101, front contact 2ES, back contact 2EF, conductor 165, contact 2RMS, and conductor 149. Therefore, the stick circuit through contact 3TR for relay TR remains closed. Because contact 2TR thus remains closed, relays P1 and P2 are again energized in sequence, and then deenergized in sequence with a certain time delay and lamp d6 is extinguished. Relay DF is now deenergized, relay EF is energized, and relays DZ and EZ are energized. Relay CM is now deenergized because its circuit through contact 2EF is opened. As a result, relay CMS is deenergized and begins to drop out. Relay TR is also deenergized as are relays T10 and DR. The lamp M is now extinguished and lamp P is energized. After lamp P is energized, relay CMS drops out. Only relays BZ, DZ, EZ, EF and ES remain energized and there is only one energized lamp in row b, and one energized lamp in row d.

*Player makes fifth move—an incorrect move*

To complete the game the player now operates button PB, deenergizing lamp b1, energizing relays BL and BN and deenergizing relays BZ and EZ. Relays BL, BN, DZ, EF and ES are now energized.

*Apparatus makes fifth move to win game*

The player now operates transfer button MTR and relays TR, T1 to T10, CM and CMS are energized while relay BL is deenergized. Relay

DRZ is now energized through contact 1TR, conductor 105, back contact 1DR, back contact 1CR, back contact 1PR, back contact 1AR, conductor 107, front contact 1ES, front contact 1EF, back contact 1EZ, conductor 151, back contact 1AZ, back contact 1BZ, back contact 1CZ, contact 1BZ and conductor 169. Contact 1DRZ is now closed and relay DR is energized through this contact in a circuit which is otherwise the same as the energizing circuit for relay DRZ.

After relay T10 is energized, relays T1 to T9 are deenergized with the usual time delay and lamp M is energized and dimmed. When relay T9 drops out relays P1 and P2 are energized in sequence and relay P1 is deenergized and drops out after a predetermined interval of time. Because contact 1P1 and front contact 3P2 are closed, relay D is energized, relay D1 is energized and the last energized lamp d1 is extinguished. The apparatus has now won the game.

#### *Indicating and resetting operation*

Because all of the lamps a1, b1, c1 and d1 are deenergized, relay MW is energized in a circuit through contact 2A7, contact 2B7, contact 2C7, contact 2D7, conductor 171, and front contact 1P2. The total games counter TP is energized through closed contact 2MW and, therefore, indicates that another game has been completed. The counter MWC, which indicates the number of games won by the apparatus is also energized through contact 3MW. The lamps are also prepared for another game by the closure of relay S21 in a circuit through contact 4MW, conductor 173, back contact 3Q, back contact 3P, front contact 3N, conductor 175, contact 2S11, and conductor 177. Relay RE is energized through contact 1MW.

Relay S22 is energized because contact 3S21 is closed. Contact 1RE is opened when relay RE is energized and, therefore, relay A1 is deenergized because its holding circuit through contact 1RE, conductor 133, conductor 175, contact 3A1, is opened. In the same manner, relays B1, C1 and D1 are deenergized and the corresponding lamps are energized. Because contact 5A1 is now open, relay AN, which was energized through conductor 95, contact 5A2, contact 5A1, and contact 3A, is deenergized. In the same manner, relays BN and CN are deenergized. Relay CM, which was locked in through contact 3CM, is deenergized when contact 3P1 opens. Relay D is deenergized because its circuit is opened at contact 1P1. Relay DR is deenergized because its holding circuit is opened at contact 1TR, relay TR being deenergized because its holding circuit is open at 1RE. The holding circuit for relay DRZ is also opened at contact 1TR. When P1 is deenergized, P2 is also deenergized, but does not drop out.

The holding circuit for relay A2 is broken when front contact 2A1 is opened. The same is true of relays A3 and A4. In the same manner, relays E2, B3, B4, C2, C3, C4, D2, D3 and D4 are deenergized and the corresponding lamps are energized. When relay T10 is deenergized, lamp M is deenergized and lamp P is energized. When relay CM is deenergized, relay CMS is deenergized since its holding circuit is opened. When front contact 2A2 opens, the sealing circuits for relays A5, A6 and A7 are opened and these relays are deenergized. In the same manner, relays B5, B6, B7, C5, C6, C7, D5, D6 and D7 are deenergized and the corresponding lamps are energized. At this time a sufficient interval has

elapsed so that relay P2 drops out. Since relays A7, B7, C7 and D7 are deenergized, the circuit for relay MW is opened and it becomes deenergized. Relay RE is, therefore, deenergized and after a predetermined time interval it drops out. Moreover, counters TP and MWC are deenergized. Moreover, when relay S21 was energized, relay P was energized in a circuit through contact 2Q, conductor 177, contact 1S21, and relay S22. At this time relay CMS drops out. When relay P is energized, relay N is deenergized because its circuit is opened at contact 2P. For the same reason, relay S11 is deenergized. Relay S12 is opened up because contact 3S11 is opened. The contacts of S22 close and relays A1, A2, A3, A4, B1, B2, B3, D1 and D2 are energized in the same manner as the corresponding relays were energized when relay S12 was energized for combination No. 1. The corresponding lamps a1, a2, a3, a4, b1, b2, b3, d1 and d2 are deenergized and the relays AZ, AF, BS, CZ, CF, CS, DZ, DS, EN and EF are energized in preparation for a second game.

The apparatus is now prepared for another game. The array of energized lamps is, however, different than at the beginning of the first game. In this case there are three lamps energized in row a, four in row b, seven in row c and five in row d, corresponding to combination No. 2.

Another game may be repeated in the manner described above, and after the end of this game, the apparatus sets up combination No. 3. This continues until combination No. 9 is set up, and after that combination No. 1 is set up again.

Although we have shown and described certain specific embodiments of our invention, we are fully aware that many modifications thereof are possible. Our invention, therefore, is not to be restricted except insofar as is necessitated by the prior art and by the spirit of the appended claims.

#### *We claim as our invention:*

1. In combination, a predetermined number of elements, each of said elements having a plurality of possible electrical conditions and means responsive to the condition of said elements and actuable only if the number of said elements in one of said conditions includes the  $n$ th power of  $r$ , where  $r$  is an integer and  $n$  is zero or an integer.

2. In combination, a predetermined number of elements, each of said elements having at least two possible electrical conditions and means responsive to the condition of said elements and actuable only if the number of said elements in one of said conditions includes the  $n$ th power of 2 where  $n$  is zero or an integer.

3. In combination, a predetermined number of elements, each of said elements having at least two possible electrical conditions, a separate circuit controlling means for each of the powers of 2 included in said number and means for actuating said circuit controlling means in dependence upon the powers of 2 included in the number of said elements that are in one of said conditions.

4. In combination, a predetermined number of elements, each of said elements having at least two possible electrical conditions, selective means for controlling the condition of said elements, a separate circuit controlling means for each of the powers of 2 included in said number and means responsive to said selective means for actuating said circuit controlling means in dependence upon the powers of 2 included in the number of said elements that are in one of said conditions.

5 5. In combination, a plurality of sets of elements, each set having a predetermined number of like elements and each element having at least two possible electrical conditions, means responsive to the condition of said elements in said sets and actuable if the number of the elements in any set in one of said conditions includes the  $n$ th power of 2 where  $n$  is zero or an integer and means to be actuated by said responsive means  
10 when the sum of total number of occurrences of each power of 2 in all said sets is even.

15 6. In combination, a plurality of sets of elements, each set having a predetermined number of like elements and each element having at least two possible electrical conditions, means responsive to the condition of said elements in said sets and actuable in each of the powers of 2 included in the number of elements in one of said conditions occurs an even number of times  
20 in said sets.

25 7. In combination, a predetermined number of sets of elements, each of said elements having at least two possible electrical conditions and each set having a predetermined number of said elements, selective means for controlling the condition of said elements and means responsive to said selective means if each of the powers of 2 included in the number of elements in one of said conditions occurs an even number of times  
30 in said sets.

35 8. In combination, a predetermined number of sets of elements, each of said elements having at least two possible electrical conditions and each set having a predetermined number of said elements, selective means for controlling the condition of said elements, a circuit controller corresponding to each of the powers of 2 included in the number of elements in each said set, means responsive to said selective means for actuating  
40 said circuit controller in dependence upon the powers of 2 included in the numbers of elements in said sets that are in a predetermined condition and means actuable by said responsive means if each of the powers of 2 included in the number of elements in said one of said conditions occurs  
45 an even number of times in said sets.

50 9. In combination, a plurality of sets of elements, each element having at least two electrical conditions and each set having a predetermined number of elements, selective means for initially maintaining certain of said elements in one of said conditions and certain others in another of said conditions, means for reverting all said elements to said other condition in a sequence which is predeterminable at will and means cooperative  
55 with said selective means after said elements have been reverted to said other conditions for reverting certain of said elements to said one of said conditions while the remainder are in said other condition, the number of said elements reverted to said one of said conditions being different than the number initially maintained in said one of said conditions.

60 10. In combination, a plurality of sets of elements, each said set having a predetermined number of elements and said elements having at least two conditions, means for altering the condition of the elements in each said set at will and means for preventing the alteration of the condition of the elements in any other set at will after the condition of the elements in one said set has been altered at will.

75 11. In combination, a plurality of sets of elements, each said set having a predetermined

number of elements and said elements having at least two conditions, means for altering the condition of the elements in each said set at will, said altering means being operable repeatedly and including means cooperative with said elements  
5 for altering the condition of a different element in a set for each successive operation of said altering means, and means for preventing the alteration of the condition of one element in any other set at will after the condition of the elements in one said set has been altered at will.

12. In combination, a plurality of sets of elements, each said set having a predetermined number of elements and said elements having at least two conditions, means for altering the condition of the elements in each said set at will, and means, responsive to the number of elements in a predetermined condition remaining in said sets after an alteration, for automatically altering the condition of said elements in said sets.

15 13. In combination, a plurality of sets of elements, each said set having a predetermined number of elements and said elements having at least two conditions, means for altering the condition of the elements in each said set at will, and means, responsive to the number of elements in a predetermined condition remaining in said sets after an alteration, for automatically altering the condition of said elements in said sets, said responsive means producing an alteration of one type when each of the powers of 2 included in the number of elements in one condition in said sets occurs an even number of times in said sets and an alteration of another type when any  
25 power of 2 included in the number of elements in said one condition occurs an odd number of times in said sets.

30 14. In combination, a plurality of sets of elements, each said set having a predetermined number of elements and said elements having at least two conditions, means for altering the condition of the elements in each said set at will, means for preventing the alteration of the condition of the elements in any other set at will after the condition of the elements in one said set has been altered at will and means for automatically altering the conditions of the elements in said sets in response to the number of elements in one condition remaining in said sets after an alteration at will.

40 15. In combination, a plurality of sets of elements, each said set having a predetermined number of elements and said elements having at least two conditions, means for altering the condition of the elements in each said set at will, means for preventing the alteration of the condition of the elements in any other set at will after the condition of the elements in one said set has been altered at will and means for automatically altering the conditions of the elements in said sets in response to the number of elements in one condition remaining in said sets after an alteration at will, said automatically altering means producing an alteration of one type when  
55 each of the powers of 2 included in the number of elements in one condition in said sets occurs an even number of times in said sets and an alteration of another type when any power of 2 included in the number of elements in said one condition in said sets occurs an odd number of times in said sets.

60 16. In combination, a plurality of sets of elements, each said set having a predetermined number of elements and said elements having at  
75

least two conditions, means for altering the condition of the elements in each said set at will, said altering means being operable repeatedly, and including means cooperative with said elements for  
 5 altering the condition of a different element in a set for each successive operation thereof, means for preventing the alteration of the condition of one element in any other set at will after the  
 10 condition of the elements in one said set has been altered at will and means for automatically altering the conditions of the elements in said sets in response to the number of elements in one condition remaining in said sets after an alteration at  
 15 will, said automatically altering means producing an alteration of one type when each of the powers of two included in the number of elements in one condition in said sets occurs an even number of times in said sets and an alteration of another  
 20 type when any power of 2 included in the num-

ber of elements in said one condition in said sets occurs an odd number of times in said sets.

17. In combination, a plurality of sets of elements, each said set having a predetermined number of elements and said elements having at  
 5 least two conditions, means for altering the condition of the elements in each said set at will, means for preventing the alteration of the condition of the elements in any other set at will  
 10 after the condition of the elements in one said set has been altered at will and means for automatically altering the conditions of the elements in said sets in response to the number of elements in one condition remaining in said sets after an  
 15 alteration at will and means for rendering said preventing means ineffective after an operation of said automatically altering means.

EDWARD U. CONDON.  
 GEREED L. TAWNEY.  
 WILLARD A. DERR.